

## Product information sheet ANDANO 700-IF

Item no. 522969

### Benefits

---



- Unique composition of optical and functional elements
- The harmonious interplay between the radii and surface design creates a modern appeal
- High quality features consisting of a covered C-overflow and InFino drain system – gracefully integrated and easy-care
- Large bowl capacity and fully utilisable base
- Elegant IF flat-rim for flushmount and for installation from above
- Optional premium accessories are available

## Planning information

---

- Note: Installing a kitchen mixer tap, drain remote control or soap dispenser in laminate worktops requires a flexible sealing tape.
- Please order drain connections for combinations of two individual bowls separately.

## Scope of supply

---

- waste kit with space-saving pipe
- 3 ½" InFino basket strainer
- fixing kit

## Details

---

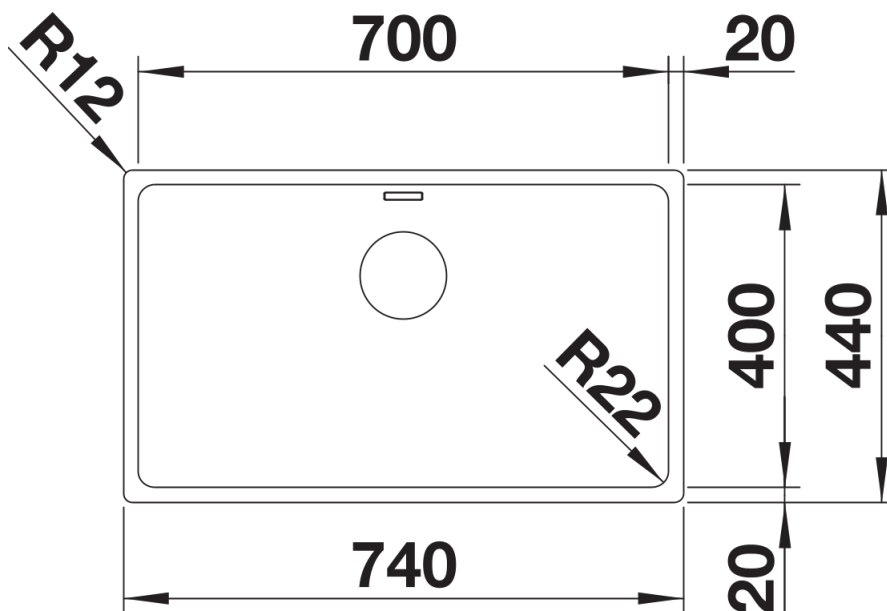

Top view

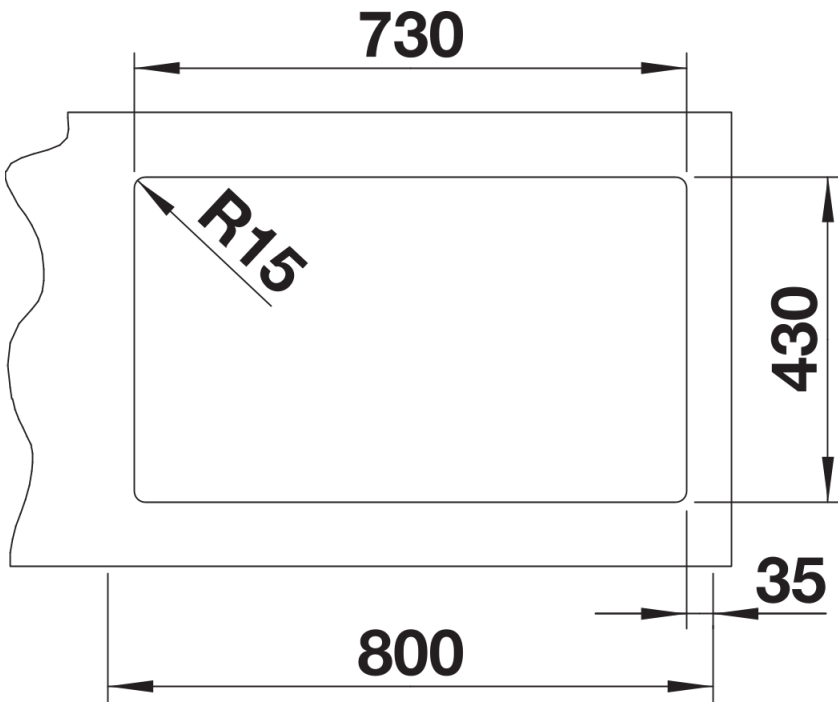

Cut-out

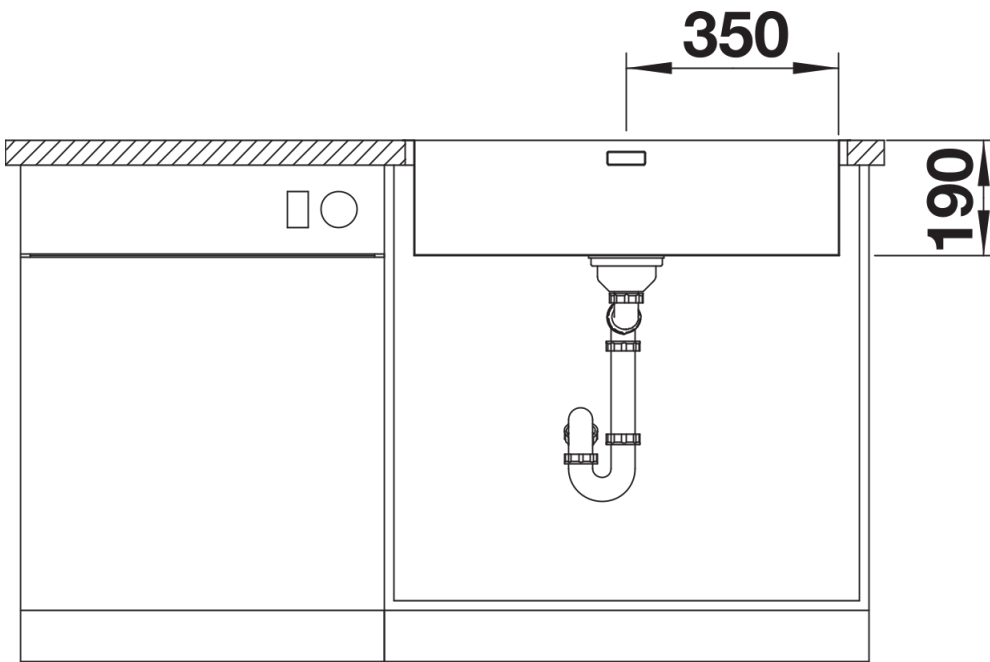

Front view

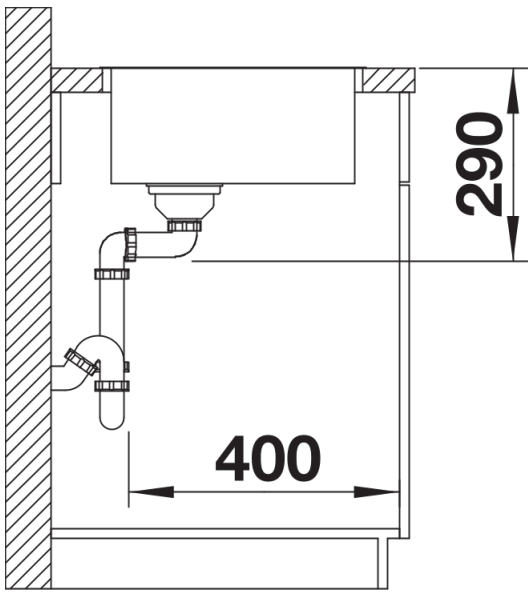

Side view